

Odečtová smyčka pro uživatele

## Bytový měřič tepla ultrazvukový HYDROMETER Sharky 775 a 774 Danfoss SONOMETER 1000 - 1100

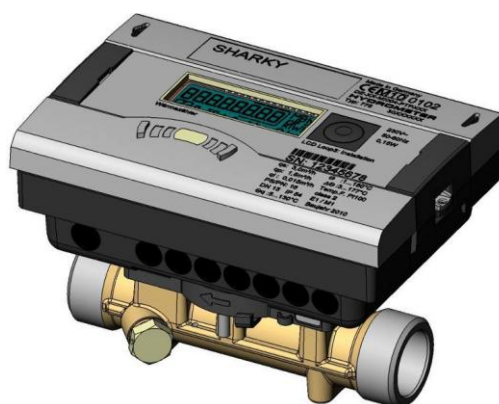

### Jednoduchý provoz

Tlačítko umístěné v přední části kalkulátoru slouží k přepínání různých displejů. Tlačítko lze stisknout krátce nebo dlouze. Krátkým stisknutím tlačítka (<3 sekundy) přepnete na další displej v rámci smyčky a dlouhým stisknutím tlačítka (>3 sekundy) přepnete na další smyčku displeje. Základní displej je okno „Energie“ (sekvence 1,1) v hlavní smyčce.

Kalkulátor se automaticky přepne do úsporného režimu, pokud tlačítko nebude stisknuto po dobu cca 4 minut, a vrátí se do základního zobrazení, pokud tlačítko znovu stisknete. Nastavení smyček lze naprogramovat tak, aby vyhovovalo individuálním požadavkům zákazníka, pomocí softwaru IZAR@SET.

Smyčka 1/main loop/  
Smyčka 2/accounting date look/

Aktuální spotřeba tepla – kWh; MWh; J  
Spotřeba tepla k 31.12 – navolit Accd 2A – přepíná se automaticky mezi datem a spotřebou energií/ kWh;MWh; J/

Nebo  
Smyčka 6/montly value look/

Spotřeba tepla k 31.12 – navolit k 31.12 - přepíná se automaticky mezi datem a spotřebou energií/ kWh; MWh; J/

Podrobnosti jsou uvedeny na následujících stránkách

## Main loop (1)

Sequence Window 1

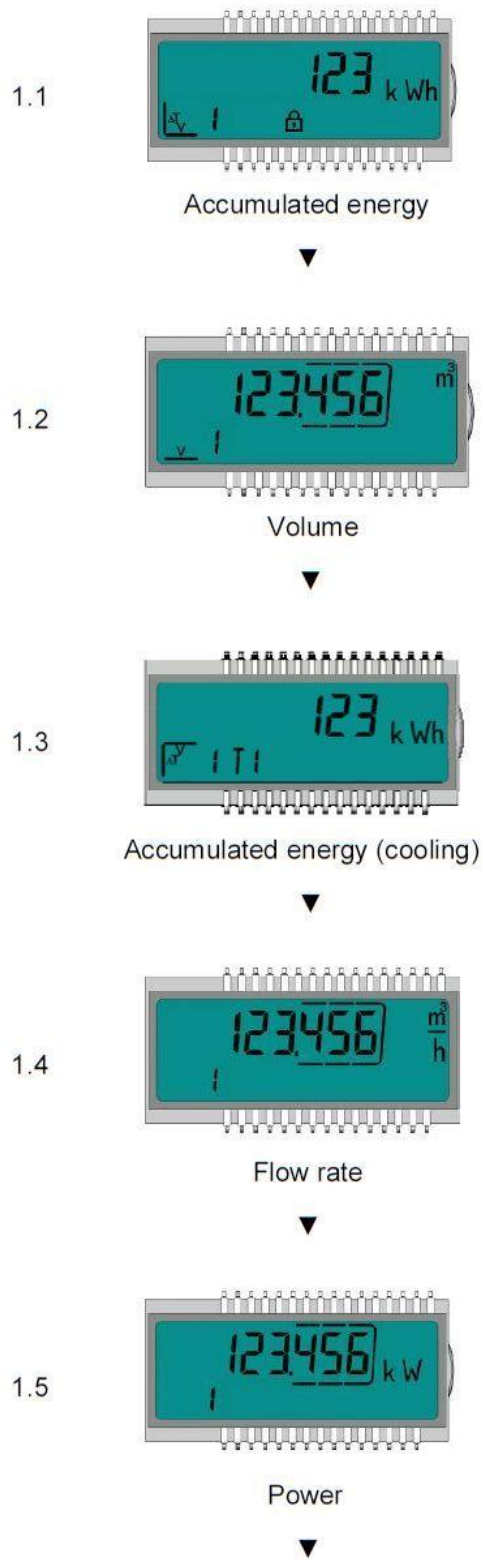

1.6



Forward/- Return temperature



1.7



Temperature difference



1.8



Operating days

2s



error hours



1.9



Error code



1.10











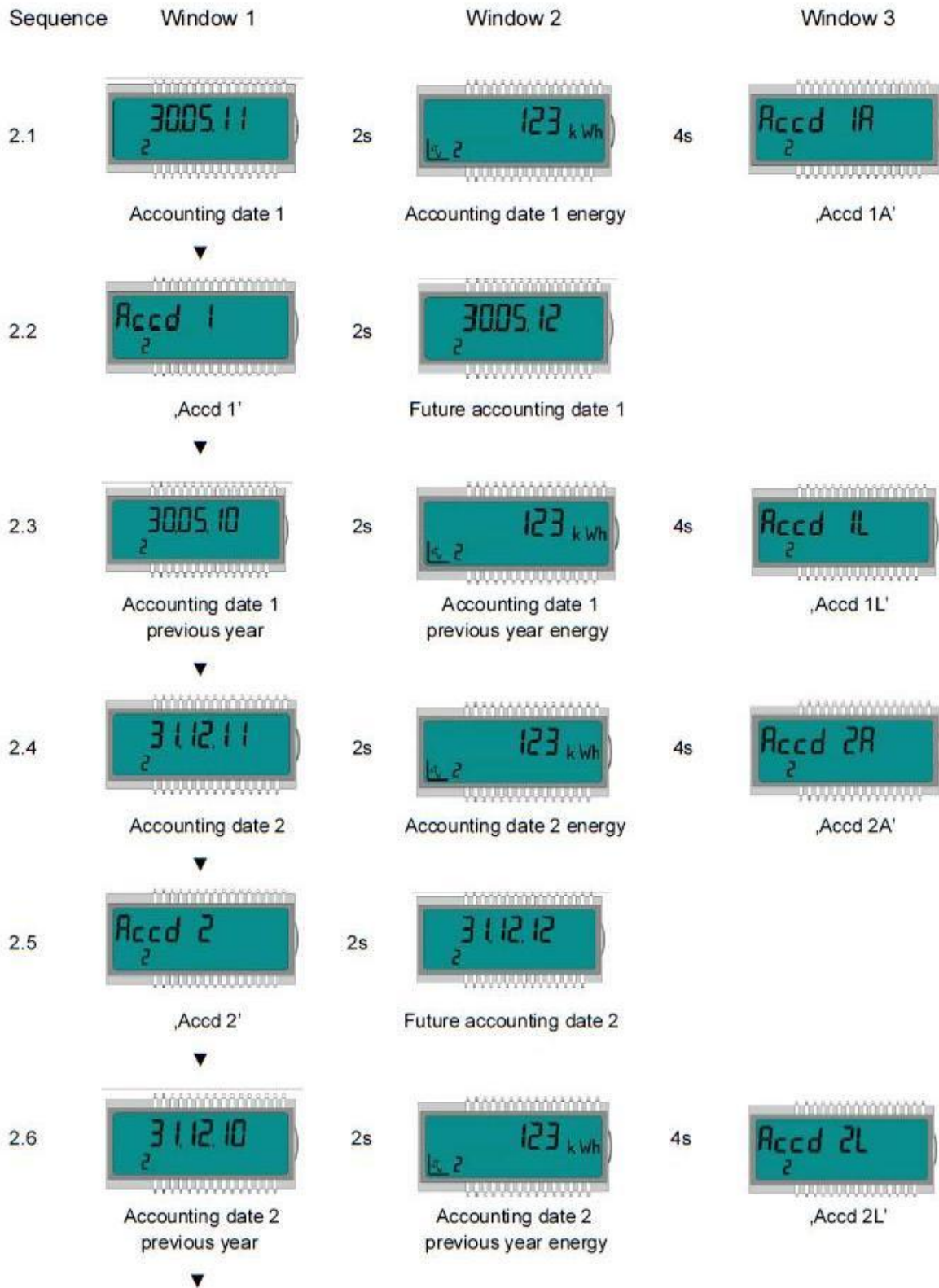







Display test



Sequence 1.1

## Accounting date loop (2)



Sequence	Window 1	Window 2	Window 3
2.7	 Accounting date 1	2s  Pulse input 1	4s  Pulse input volume 1
	▼		
2.8	 Accounting date 1 previous year	2s  Pulse input 1	4s  Pulse input volume 1
	▼		
2.9	 Accounting date 2	2s  Pulse input 1	4s  Pulse input volume 1
	▼		
2.10	 Accounting date 2 previous year	2s  Pulse input 1	4s  Pulse input volume 1
	▼		
2.11	 Accounting date 1	2s  Pulse input 2	4s  Pulse input volume 2
	▼		
2.12	 Accounting date 1 previous year	2s  Pulse input 2	4s  Pulse input volume 2
	▼		

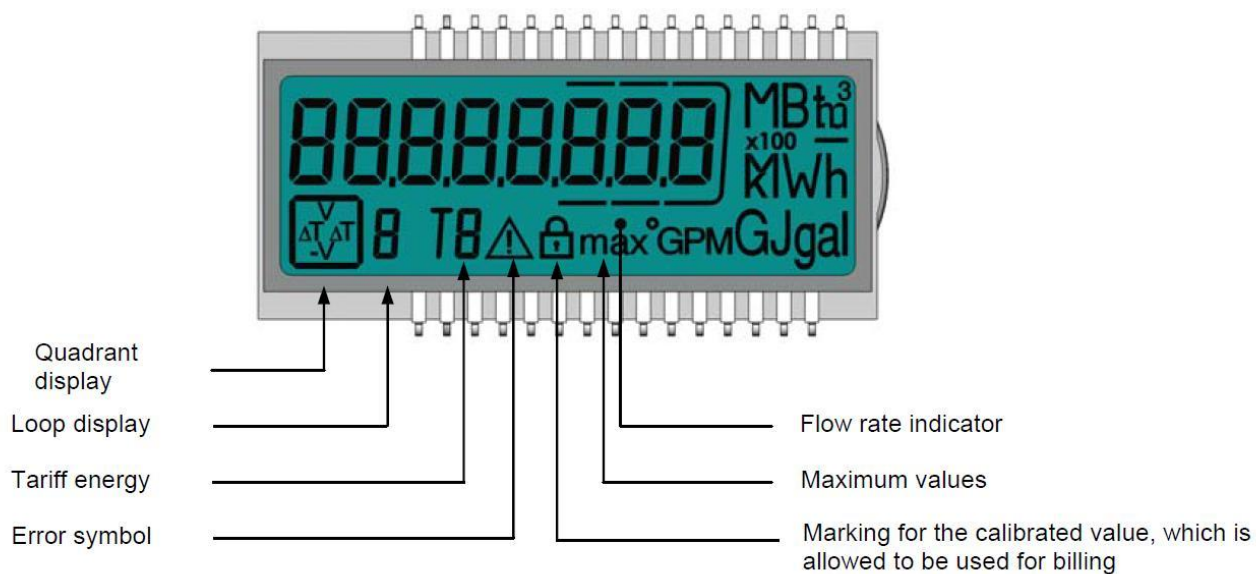
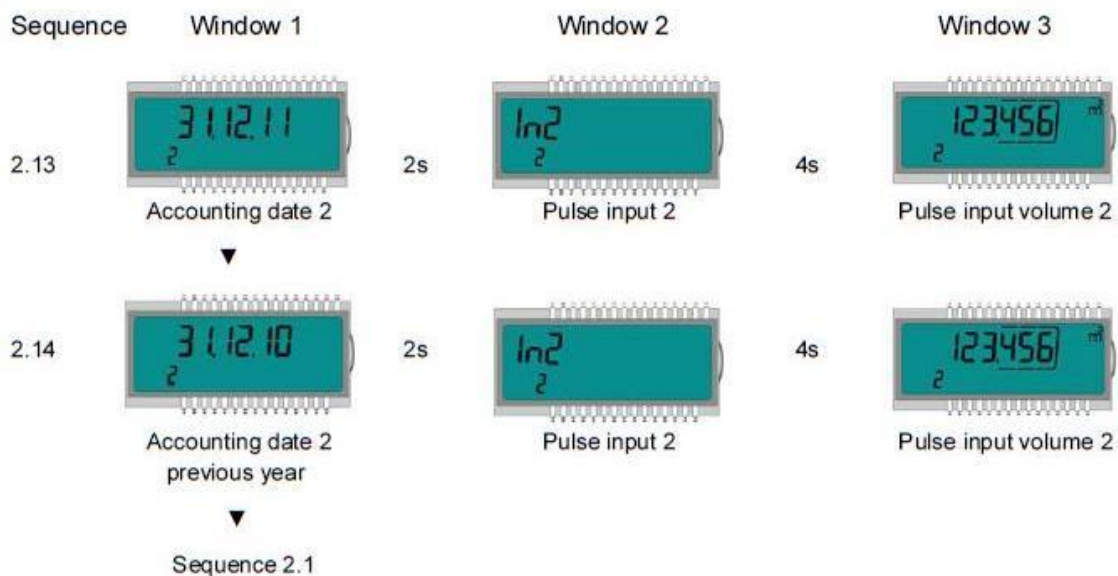

podrobný popis všech smyček naleznete na  
<http://www.irtn.cz/odecet-navody.html>